

Minimum Bit Error Rate Multiuser Detection in Multiple Antenna Aided OFDM

M. Y. Alias, A. K. Samingan, S. Chen, ¹L. Hanzo
Dept. of ECS., Univ. of Southampton, SO17 1BJ, UK.
Tel: +44-703-593 125, Fax: +44-703-593 045
Email: ¹lh@ecs.soton.ac.uk, <http://www-mobile.ecs.soton.ac.uk>

Abstract— In this contribution, we propose a Minimum Bit Error Rate (MBER) multiuser detector for Space Division Multiple Access (SDMA) aided Orthogonal Frequency Division Multiplexing (OFDM) systems. It is shown that the MBER detector outperforms the Minimum Mean Squared Error (MMSE) detector, since the MBER detector directly minimizes the BER, while MMSE detector minimizes the mean-squared error (MSE), which does not guarantee achieving the minimum BER. When supporting two users, the proposed MBER scheme substantially outperforms the classic MMSE arrangement in the investigated propagation scenario.

I. INTRODUCTION

IN an effort to increase the achievable system capacity of an OFDM system, antenna arrays can be employed for supporting multiple users in a Space Division Multiple Access (SDMA) communications scenario [1-4]. The benefit of this system is that in case of employing a sufficiently high number of receiver antennas at the base station, the degree of freedom provided by the P number of base station receiver antennas and L number of transmit antennas is higher than necessary for supporting L number of simultaneous users. Hence, the remaining degrees of freedom allow us to increase the achievable receiver diversity gain of the system and therefore contributes towards improving the system's transmission integrity.

A variety of linear multiuser detectors have been proposed for performing the separation of OFDM users based on their unique, user-specific, spatial signature provided that their channel impulse response was accurately estimated [2,4]. The most popular design strategy is constituted by the minimum mean-squared-error (MMSE) multiuser detector (MUD). However, as recognised in [5-8], a better strategy is to choose the linear detector's coefficients so as to directly minimize the error-probability or bit-error rate (BER), rather than the mean-squared error (MSE). This is because minimizing the MSE does not necessarily guarantee that the BER of the system is also minimized. The family of detectors that directly minimizes the BER is referred to as the minimum bit-error rate (MBER) detector [9,10]. In this contribution, we will investigate the performance of the proposed MBER linear MUD in the context of an uplink SDMA/OFDM system.

II. SPACE DIVISION MULTIPLE ACCESS SYSTEM MODEL

The so-called SDMA system is capable of differentiating L users' transmitted signals at the base-station (BS) invoking their unique, user-specific spatial signature created by the channel transfer functions or channel impulse responses (CIR) between the users' single transmit antenna and the P different receiver antennas at the BS [1], [4].

Figure 1 portrays the antenna array aided uplink transmission scenario considered. In this figure, each of the L simultaneous users is equipped with a single transmission antenna, while the receiver capitalizes on a P -element antenna front-end [11]. The set of complex signals, $x_p[n, k], p \in 1, \dots, P$ received by the P -element antenna array in the k -th subcarrier of the n -th OFDM symbol is constituted by the superposition of the independently faded signals associated with the L users sharing the same space-frequency resource [4]. The received signal was corrupted by the Gaussian noise at the array elements. The indices $[n, k]$ have been omitted for notational convenience during our forthcoming discourse, yielding [4]:

$$\mathbf{x} = \mathbf{H}\mathbf{s} + \mathbf{n} = \bar{\mathbf{x}} + \mathbf{n}, \quad (1)$$

where the $(P \times 1)$ -dimensional vector \mathbf{x} of the received signals, the vector of transmitted signals \mathbf{s} and the array noise vector \mathbf{n} , respectively, are given by:

$$\mathbf{x} = (x_1, x_2, \dots, x_P)^T, \quad (2)$$

$$\mathbf{s} = (s_1, s_2, \dots, s_L)^T, \quad (3)$$

$$\mathbf{n} = (n_1, n_2, \dots, n_P)^T. \quad (4)$$

Furthermore, $\bar{\mathbf{x}}$ represents the noiseless component of \mathbf{x} . The frequency domain channel transfer function matrix \mathbf{H} of dimension $P \times L$ is constituted by the set of channel transfer function vectors of the L users:

$$\mathbf{H} = (\mathbf{h}_1, \mathbf{h}_2, \dots, \mathbf{h}_L), \quad (5)$$

each of which describes the frequency domain channel transfer function between the single transmitter antenna associated with a particular user l and the reception array elements $p \in 1, \dots, P$:

$$\mathbf{h}_l = (h_{1l}, h_{2l}, \dots, h_{Pl})^T. \quad (6)$$

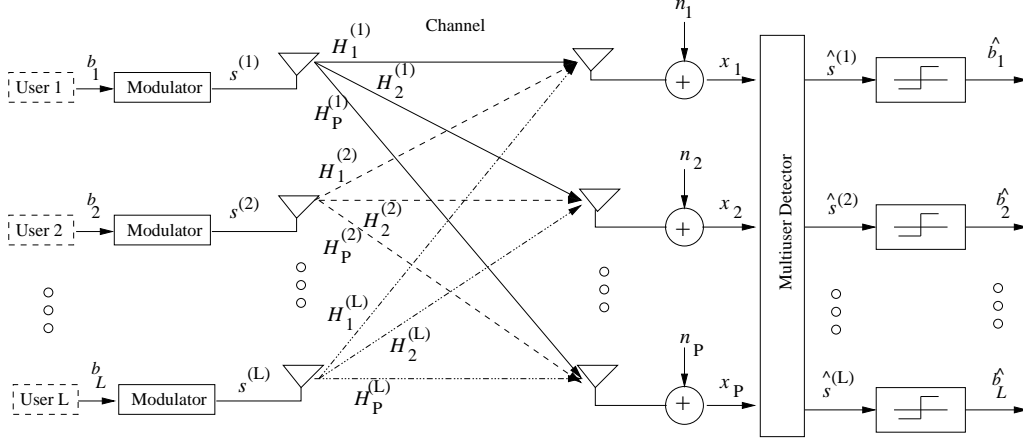

Fig. 1. Schematic of an antenna array aided OFDM uplink scenario, where each of the L users is equipped with a single transmit antenna and the BS's receiver is assisted by a P -element antenna front-end.

The complex data signal, s_l , transmitted by the l -th user, $l \in 1, \dots, L$ and the AWGN noise process, n_p , at any antenna array element $p, p \in 1, \dots, P$ are assumed to exhibit a zero mean and a variance of σ_l^2 and σ_n^2 for the data signal and AWGN noise process, respectively. The frequency domain channel transfer functions, H_{pl} of the different array elements $p \in 1, \dots, P$ for users $l \in 1, \dots, L$ are independent, stationary, and complex Gaussian distributed processes with zero-mean and unit variance. For linear multiuser detectors, the estimate $\hat{\mathbf{s}}$ of the transmitted signal vector \mathbf{s} of the L simultaneous users is generated by linearly combining the signals received by the P different antenna elements at the BS with the aid of the array weight matrix \mathbf{W} , resulting in:

$$\hat{\mathbf{s}} = \mathbf{W}^H \mathbf{x}. \quad (7)$$

By substituting Equation 1 into Equation 7 and considering the l -th user's associated vector component, we will arrive at:

$$\begin{aligned} \hat{s}_l &= \mathbf{w}_l^H \mathbf{x}, \\ &= \mathbf{w}_l^H \mathbf{H} \mathbf{s} + \mathbf{w}_l^H \mathbf{n} = \bar{s}_l + \mathbf{w}_l^H \mathbf{n}, \\ &= \mathbf{w}_l^H \mathbf{H}_l s_l + \mathbf{w}_l^H \sum_{i=1, i \neq l}^L \mathbf{H}_i s_i + \mathbf{w}_l^H \mathbf{n}, \end{aligned} \quad (8)$$

where the weight vector \mathbf{w}_l is the l -th column of the weight matrix \mathbf{W} . The first term of Equation 8 refers to the desired user's contribution, while the second and third term represent the interfering users' contributions and the Gaussian noise, respectively. At the current state-of-the-art, the most popular MUD strategy is the MMSE design, where \mathbf{w}_l is chosen as the unique vector minimizing the MSE expressed as $\text{MSE} = E[(\hat{s}_l - s_l)^2]$, namely as [4]:

$$\mathbf{w}_{l(\text{MMSE})} = (\mathbf{H} \mathbf{H}^H + \sigma_n^2 \mathbf{I})^{-1} \mathbf{H}_l, \quad (9)$$

where \mathbf{H}_l is the l -th column of the system matrix \mathbf{H} .

III. ERROR PROBABILITY IN A BPSK SYSTEM

In this paper the term BER and probability of error P_E are used interchangeably. The BER encountered at the out-

put of the MUD \mathbf{w}_l of user l may be expressed as [12]:

$$\begin{aligned} P(\mathbf{w}_l) &= Pr[\text{sgn}(b_l) \cdot \bar{s}_l(\mathbf{w}_l) < 0], \\ &= Pr[z_l < 0], \end{aligned} \quad (10)$$

where z_l is the signed decision variable given by:

$$z_l = \text{sgn}(b_l) \cdot \bar{s}_l(\mathbf{w}_l). \quad (11)$$

The Probability Density Function (PDF) of the decision variable z_l is constituted by a mixture of the Gaussian distribution associated with each possible combination of the transmitted data symbols of all users. Under the assumption that all the noise-free signal states are equiprobable, the PDF of z_l is given by [12]:

$$p_{z_l}(z_l) = \frac{1}{N_b \sqrt{2\pi} \sigma_n \sqrt{\mathbf{w}_l^H \mathbf{w}_l}} \sum_{j=1}^{N_b} e^{-\frac{(z_l - \text{sgn}(b_l^{(j)}) \bar{s}_l^{(j)})^2}{2\sigma_n^2 \mathbf{w}_l^H \mathbf{w}_l}}, \quad (12)$$

where N_b is the number of equiprobable combinations of the binary vectors of the L users, i.e. we have $N_b = 2^L$. Furthermore, $\bar{s}_l^{(j)}$, $j \in 1, \dots, N_b$, denotes the noiseless signal at the output of the MUD related to the l -th user, while $b_l^{(j)}$, $j \in 1, \dots, N_b$, is the transmitted bit of user l .

The erroneous decision events are associated with the area under the PDF curve in the interval $(-\infty, 0)$, which is quantified as:

$$P_E(\mathbf{w}_l) = \int_{-\infty}^0 p_z(z_l; \mathbf{w}_l) dz_l. \quad (13)$$

Upon using the integration by substitution technique and introducing the shorthand of

$$y_j = \frac{(z_l - \text{sgn}(b_l^{(j)}) \bar{s}_l^{(j)})^2}{2\sigma_n^2 \mathbf{w}_l^H \mathbf{w}_l}, \quad (14)$$

the probability of error in Equation 13 becomes:

$$\begin{aligned} P_E(\mathbf{w}_l) &= \frac{1}{N_b \sqrt{2\pi}} \sum_{j=1}^{N_b} \int_{-\infty}^{c_j(\mathbf{w}_l)} \exp\left(-\frac{y_j}{2}\right) dy_j \\ &= \frac{1}{N_b} \sum_{j=1}^{N_b} Q[c_j(\mathbf{w}_l)], \end{aligned} \quad (15)$$

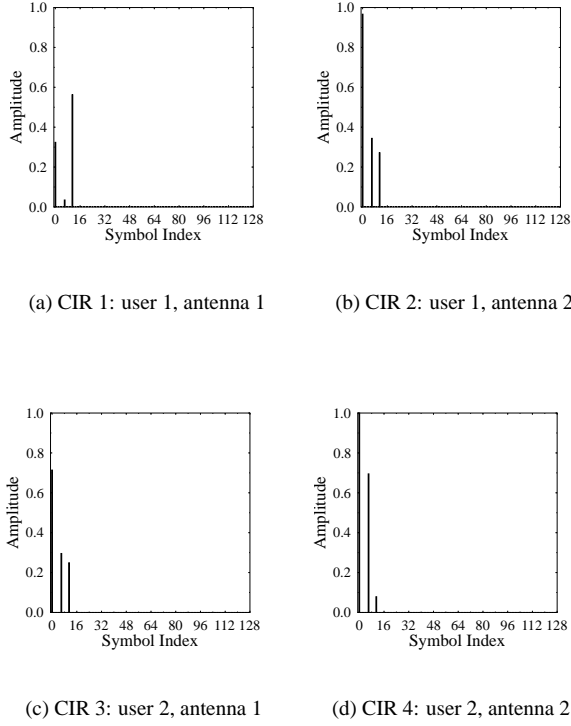

Fig. 2. Four different channel impulse responses (CIR) recorded at the two receiver antennas for the two users supported.

where $c_j(\mathbf{w}_l)$ is given by:

$$c_j(\mathbf{w}_l) = \frac{\text{sgn}(b_l^{(j)}) \cdot \bar{s}_l^{(j)}}{\sigma_n \sqrt{\mathbf{w}_l^H \mathbf{w}_l}} = \frac{\text{sgn}(b_l^{(j)}) \cdot \mathbf{w}_l^H \bar{\mathbf{x}}_j}{\sigma_n \sqrt{\mathbf{w}_l^H \mathbf{w}_l}} \quad (16)$$

where $\bar{\mathbf{x}}_j$, $j \in 1, \dots, N_b$ constitutes a possible value of $\bar{\mathbf{x}}$ defined in the context of Equation 1. Note that the BER is invariant to a positive scaling of the weight vector, in other words, the BER depends only on the vectorial direction of \mathbf{w}_l , but not on its magnitude.

IV. EXACT MBER MULTIUSER DETECTION

The MBER solution is defined as [12]:

$$\mathbf{w}_{l(MBER)} = \arg \min_{\mathbf{w}_l} P_E(\mathbf{w}_l). \quad (17)$$

However, the complex, irregular shape of the BER cost function prevents us from deriving a closed-form solution for the MBER MUD weights. Therefore in practice an iterative strategy based on the steepest-descent gradient method can be used for finding the MBER solution [12]. According to this method, the linear MUD's weight vector \mathbf{w}_l is iteratively updated, commencing for example from the MMSE weights of Equation 9, until the weight vector that exhibits the lowest BER is arrived at. In each step, the weight vector is updated according to a specific step-size, μ , in the vectorial direction in which the BER cost function decreases most rapidly, namely in the direction opposite to the gradient of the BER cost function given in Equation 21. The steepest-descent gradient algorithm that can be used for finding the MBER solution is summarised as follows [12]:

$$\mathbf{w}_l(i+1) = \mathbf{w}_l(i) + \mu \mathbf{d}(i), \quad (18)$$

where the step-size is represented by μ , and the update direction vector $\mathbf{d}(i)$ at instance i is given by:

$$\mathbf{d}(i) = -\nabla_{\mathbf{w}_l} P_E[\mathbf{w}_l(i)]. \quad (19)$$

In Equation 19, $\nabla_{\mathbf{w}_l} P_E[\mathbf{w}_l(i)]$ is the gradient of $P_E[\mathbf{w}_l(i)]$ with respect to \mathbf{w}_l and i indicates the iteration index. By exploiting the following identity [12]:

$$\frac{\partial}{\partial t} \int_{a(t)}^{c(t)} f(y) dy = f[c(t)] \frac{\partial c(t)}{\partial t} - f[a(t)] \frac{\partial a(t)}{\partial t}, \quad (20)$$

the gradient of $P_E(\mathbf{w}_l)$ with respect to the MUD's weight vector \mathbf{w}_l can then be computed by:

$$\begin{aligned} \nabla_{\mathbf{w}_l} P_E(\mathbf{w}_l) &= \frac{1}{N_b \sqrt{2\pi}} \sum_{j=1}^{N_b} e^{\left(-\frac{(-\text{sgn}(b_l^{(j)}) \cdot \bar{s}_l^{(j)})^2}{2\sigma_n^2 \mathbf{w}_l^H \mathbf{w}_l} \right)} \frac{\partial c_j(\mathbf{w}_l)}{\partial \mathbf{w}_l} \\ &= \frac{1}{N_b \sqrt{2\pi} \sigma_n} \sum_{j=1}^{N_b} e^{\left(-\frac{(\bar{s}_l^{(j)})^2}{2\sigma_n^2 \mathbf{w}_l^H \mathbf{w}_l} \right)} \cdot \text{sgn}(b_l^{(j)}) \\ &\quad \cdot \left\{ \frac{-\bar{\mathbf{x}}_j}{(\mathbf{w}_l^H \mathbf{w}_l)^{\frac{1}{2}}} + \mathbf{w}_l^H \bar{\mathbf{x}}_j \frac{\mathbf{w}_l}{(\mathbf{w}_l^H \mathbf{w}_l)^{\frac{3}{2}}} \right\} \\ &= \frac{1}{N_b \sqrt{2\pi} \sigma_n} \left(\frac{\mathbf{w}_l \mathbf{w}_l^H - \mathbf{w}_l^H \mathbf{w}_l \mathbf{I}}{(\mathbf{w}_l^H \mathbf{w}_l)^{\frac{3}{2}}} \right) \\ &\quad \cdot \sum_{j=1}^{N_b} e^{\left(-\frac{(\bar{s}_l^{(j)})^2}{2\sigma_n^2 \mathbf{w}_l^H \mathbf{w}_l} \right)} \cdot \text{sgn}(b_l^{(j)}) \cdot \bar{\mathbf{x}}_j. \end{aligned} \quad (21)$$

Observe in Equation 16 that BER is independent of the magnitude of the MUD's weight vector, and the knowledge of the orientation of the detector's weight vector is sufficient for defining the decision boundary of the linear MBER detector. Therefore the MBER detector has an infinite number of solutions.

It is desirable in any optimisation problem to have a single global minimum. In the case of the proposed MBER, the MUD's global BER minimum is found by constraining the detector's weight vector to have a unity magnitude. This is achieved by introducing the normalisation process in each iteration according to:

$$\bar{\mathbf{w}}_l = \frac{\mathbf{w}_l}{\|\mathbf{w}_l\|} = \frac{\mathbf{w}_l}{\sqrt{\mathbf{w}_l^H \mathbf{w}_l}}. \quad (22)$$

With the aid of this normalisation, the gradient expression of Equation 21 can be simplified to [12]:

$$\begin{aligned} \nabla_{\mathbf{w}_l} P_E(\mathbf{w}_l) &= \frac{1}{N_b \sqrt{2\pi} \sigma_n} \sum_{j=1}^{N_b} \exp \left(-\frac{(\bar{s}_l^{(j)})^2}{2\sigma_n^2} \right) \\ &\quad \cdot \text{sgn}(b_l^{(j)}) \cdot (\bar{\mathbf{w}}_l \cdot \bar{s}_l^{(j)} - \bar{\mathbf{x}}_j), \end{aligned} \quad (23)$$

where $\bar{\mathbf{w}}_l$ is the MUD's normalised weight vector evaluated using Equation 22. Comparing the gradient expressions of Equation 21 and Equation 23, we may conclude

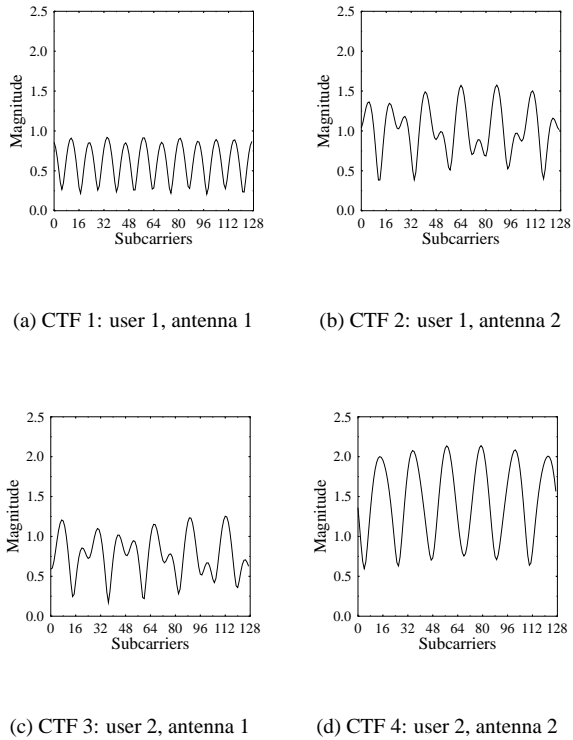

Fig. 3. Channel transfer functions (CTF) for the CIRs seen in Figure 2 (a) CTF 1, (b) CTF 2, (c) CTF 3, and (d) CTF 4.

that the constraint of Equation 22 imposed on the optimisation problem of Equation 21 reduces the infinite number of MBER solutions to a single solution. In our previous discourse we assumed the explicit knowledge of the matrix \mathbf{H} defined in Equation 1. However, in practice \mathbf{H} has to be determined on the basis of the channel impaired noisy value of \mathbf{x} and hence a number of techniques have been proposed in references [5,8,9,12] to this effect.

V. RESULTS AND DISCUSSION

In our quantitative investigations we used the simplest possible SDMA OFDM system supporting two users with the aid of two receiver antennas. As shown in Figure 1, each user has a unique channel transfer function (CTF) with respect to each receiver antenna. The four corresponding CIRs are shown in Figure 2 and the resultant CTFs are depicted in Figure 3. The CIRs represent a three-path indoor type channel [13], where no fading is experienced. Correspondingly, the time-invariant CTF 1 and CTF 2 are encountered by user 1 at the first and second receiver antenna, respectively. Similarly, CTF 3 is encountered at the first receiver antenna and CTF 4 at the second by user 2. The OFDM modem had 128 subcarriers. In our simulations, we initialised the iterative MBER algorithm to the MMSE MUD weights given by Equation 9.

The results of our simulations are shown in Figures 4, 5 and 6. The average BER of user 1 and user 2 recorded in the context of both the MMSE and MBER detector is portrayed in Figure 4. We can see from this figure that user 1 has a better average BER in conjunction with the MMSE detector compared to user 2 for SNRs in excess of about 25 dB. By contrast, the MBER detector of user 2 outperforms

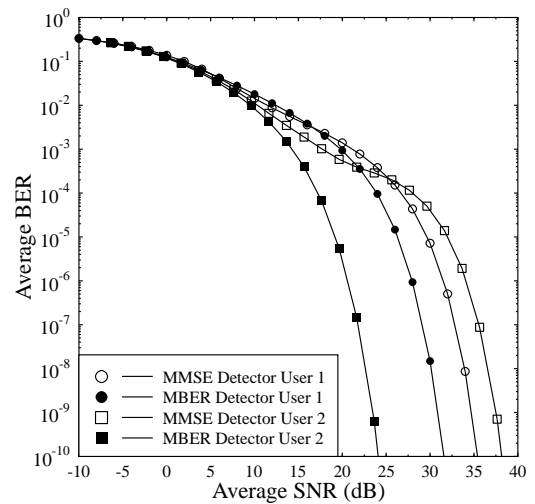

Fig. 4. Average BER versus the average SNR expressed in dB for the MMSE and the MBER multiuser detectors of user 1 and user 2 supported by two receiver antennas using 128 subcarrier OFDM communicating over the channel characterised by the CIRs and CTFs shown in Figure 2 and Figure 3, respectively.

that of user 1 in terms of the average BER. We can also see that the MBER detectors of both users have a substantially lower average BER compared to the MMSE detectors. Again, as expected, this is because the MMSE is directly minimising the MSE and not the BER. We may also note that the average BER difference between the MMSE and MBER detectors is not the same for both users. Specifically, the MBER MUD of user 2 has an SNR advantage of almost 12 dB, while that of user 1 has about 5 dB SNR advantage. This is a consequence of the unique combinations of the channel transfer functions of both users, since it can be seen in Figure 2 that the CIR of user 1 exhibits a lower ratio between the main and the delayed CIR taps than that of user 2.

In Figure 5 and Figure 6, we can see that the BER of the MMSE and MBER MUD is different for every OFDM subcarrier. This is because the particular combination of the CTFs is unique for the different OFDM subcarriers. These CTF differences will result in a time-variant system matrix, \mathbf{H} , for each OFDM subcarrier, thus imposing a direct influence on the calculation of the MUD's weight values, as suggested by Equation 9 and Equation 17 for the MMSE and MBER MUD, respectively. By comparing the BER plots of Figure 5 and Figure 6 recorded for user 1 and user 2 respectively, we can see that the BER peaks of the dramatically attenuated subcarriers of Figure 3 are substantially higher for the MMSE MUD.

VI. CONCLUSION

In this paper, we have presented the novel concept of MBER OFDM multiuser detection that directly minimises the BER in an SDMA OFDM system. We have shown that the MBER detector outperforms the MMSE detector, because the MMSE detector minimises the MSE, which does not always guarantee attaining the minimum BER. We have also shown that since different users of an SDMA

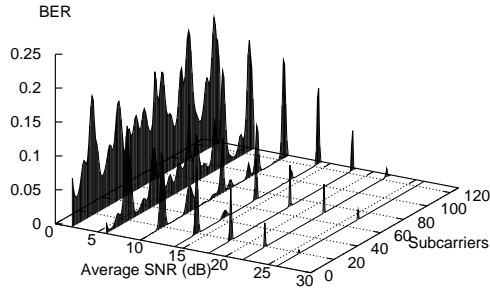

(a) MMSE

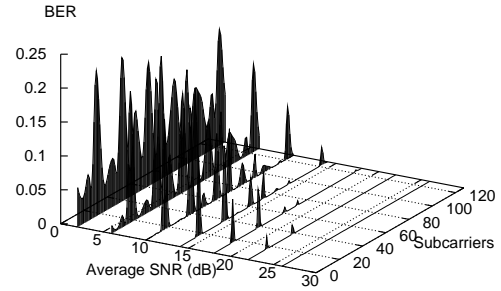

(b) MBER

Fig. 5. BER versus the average SNR for every OFDM subcarrier for the (a) MMSE, and (b) MBER multiuser detector of **user 1** when supporting two users with the aid of two receiver antennas using 128 subcarrier OFDM communicating over the channel characterised with the aid of the CIR and CTF shown in Figure 2 and Figure 3, respectively.

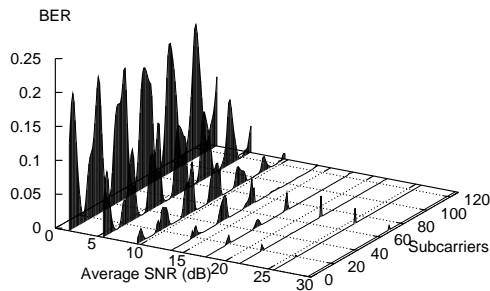

(a) MMSE

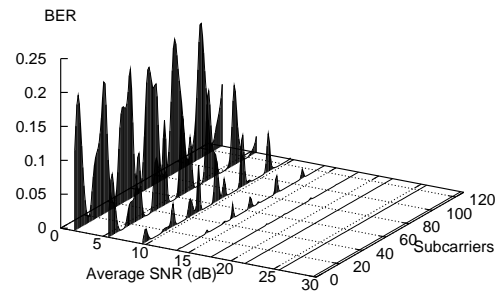

(b) MBER

Fig. 6. BER versus the average SNR for every OFDM subcarrier for the (a) MMSE, and (b) MBER multiuser detector of **user 2** when supporting two users with the aid of two receiver antennas using 128 subcarrier OFDM communicating over the channel characterised with the aid of the CIR and CTF shown in Figure 2 and Figure 3, respectively.

OFDM system will experience different unique combinations of the channel transfer functions in the context of the different antennas, their performance also varied. This is also true in the context of the subcarriers' BERs due to the frequency selective nature of the multipath channels encountered. Our future research will study the interaction of MBER MUDs and channel coding, when communicating over time-variant fading channels.

REFERENCES

- [1] B. Suard, G. Xu, H. Liu, and T. Kailath, "Uplink Channel Capacity of Space-Division-Multiple-Access Scheme," *IEEE Transactions on Information Theory*, vol. 44, no. 4, pp. 1468–1476, July 1998.
- [2] P. Vandenameele, L. Van Der Perre, M. G. E. Engels, B. Gyselinckx, and H. J. De Man, "A Combined OFDM/SDMA Approach," *IEEE Journals of Selected Areas in Communications*, vol. 18, no. 11, pp. 2312–2321, November 2000.
- [3] H. Bölcskei, D. Gesbert, and A. J. Paulraj, "On The Capacity of OFDM-Based Spatial Multiplexing Systems," *IEEE Transactions on Communications*, vol. 50, no. 2, pp. 225–234, February 2002.
- [4] L. Hanzo, M. Münster, B. J. Choi and T. Keller, *OFDM and MC-CDMA*, John Wiley and IEEE Press, West Sussex, England, 2003.
- [5] A. K. Samingan, S. Chen, and L. Hanzo, "Adaptive Minimum Symbol Error Rate CDMA Multiuser Detection for Pulse Amplitude Modulation," in *Proceedings of IEEE VTC (Spring)*, Jeju, Korea, 2003, pp. 2812–2816.
- [6] X. Wang, W.-S. Lu, and A. Antoniou, "Constrained Minimum-BER Multiuser Detection," *IEEE Transactions on Signal Processing*, vol. 48, no. 10, pp. 2903–2909, October 2000.
- [7] R. C. de Lamare and R. Sampaio-Neto, "Adaptive MBER Decision Feedback Multiuser Receivers in Frequency Selective Fading Channels," *IEEE Communications Letters*, vol. 7, no. 2, pp. 73–75, February 2003.
- [8] S. Chen, L. Hanzo, and N. N. Ahmad, "Adaptive Minimum Bit Error Rate Beamforming Assisted Receiver for Wireless Communications," in *Proceedings of IEEE International Conference of Acoustics, Speech and Signal Processing (ICASSP)*, Hong Kong, China, 2003, vol. IV, pp. 640–643.
- [9] B. Mulgrew and S. Chen, "Adaptive Minimum-BER Decision Feedback Equalizers for Binary Signalling," *EURASIP Signal Processing Journal*, vol. 81, no. 7, pp. 1479–1489, 2001.
- [10] C.-C. Yeh and J. R. Barry, "Adaptive Minimum Bit-Error Rate Equalization for Binary Signalling," *IEEE Transactions on Communications*, vol. 48, no. 7, pp. 1226–1235, July 2000.
- [11] M. Münster and L. Hanzo, "Co-channel Interference Cancellation Techniques for Antenna Array Assisted Multiuser OFDM Systems," in *3G-2000*, London, UK, March 2000, pp. 256–260.
- [12] S. Chen, A. K. Samingan, B. Mulgrew, and L. Hanzo, "Adaptive Minimum-BER Linear Multiuser Detection for DS-SSMA Signals in Multipath Channels," *IEEE Transactions on Signal Processing*, vol. 49, pp. 1240–1247, June 2001.
- [13] L. Hanzo, W. Webb, and T. Keller, *Single and Multi-carrier Quadrature Amplitude Modulation*, John Wiley, New York, 2000.